

Ductless filtering fume hoods and vented storage cabinets

Ductless fume hoods - Weighing stations - Vented storage cabinets - Stand alone filtration system for safety cabinets - PCR workstations - HEPA filtered enclosures - Portable Glove box

Designed for user safety, energy savings
and environmental protection.

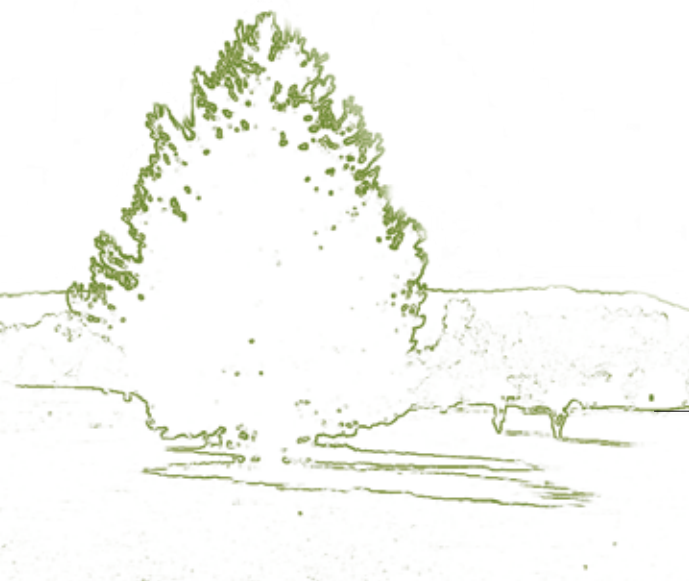

Contents

The Erlab® Group	p 2
Strong points	p 3
Quality design	p 3
Safety, environmental protection, and energy savings within your laboratory	p 4
The ESP® program	p 5
Filtration technologies	p 6
Flex® technology	p 7
Captair®Flex® Ductless fume hoods	p 8
Captair®Flex® Weighing stations	p 16
NEW Captair®store Vented storage cabinets	p 20
NEW ChemTrap Stand alone filtration system for safety cabinets	p 25
NEW Captair®flow HEPA filtered enclosure	p 26
Captair®bio PCR workstations	p 30
Captair®pyramid Portable glove box	p 31
The AFNOR NF X 15-211: 2009 standard	p 32
Asura Maintenance	p 34
NEW AsuraFilters.com	p 35
Visit us on the web	p 35

The Erlab® Group, a worldwide leader

Recognized leader in filtration technology for the protection of laboratory personnel since 1968.

Since the very beginning, we have focused all of our efforts on researching, designing, developing, and manufacturing sustainable safety solutions.

Our main objective is to offer our users the highest performance solutions in terms of protection against chemical inhalation risks in the laboratory.

Our worldwide presence, our customers capabilities, and our strong research & development activities allow us to offer advanced filtration technology solutions to laboratories in chemical, pharmaceutical, cosmetic, agro-food, hospital, and academic markets.

« The AFNOR NF X 15-211: 2009 standard attests to the high performance of our products. »

More info p.32

For Erlab, compliance with standards is fundamental. Based on scientific criteria, the AFNOR NF X 15-211: 2009 standard attests to the high performance of our products, which ensure your day-to-day safety at work.

Our experts in the field of filtered air recirculation systems allow laboratories to make safety a top priority. Furthermore, all our solutions have been designed to limit the laboratory's impact on the environment and to support one of the most important objectives of today's world: energy savings.



Europe : Erlab S.A.S. (France)



America : Erlab, Inc. (USA)



Asia : Erlab Ltd (China)



A state-of-the art R&D laboratory

Strong points

Captair® solutions are designed to protect laboratory personnel when working with chemicals. Based on filtration principles, Erlab products offer a high degree of protection against inhalation risks coming from harmful molecules and particles emitted at the workstation. The containment and filtration efficiency of these products, as demonstrated by their compliance with the AFNOR NF X 15-211: 2009 standard, make our Captair® ductless fume enclosure a reliable, flexible, economical, and environmentally-friendly solution.

Save on energy costs

The air balance necessary to run traditional ducted systems results in high energy consumption. A Captair® solution eliminates the energy costs related to systems extracting and supplying conditioned air. It is able to keep operating costs low, even when the cost related to filter replacement is taken into account.

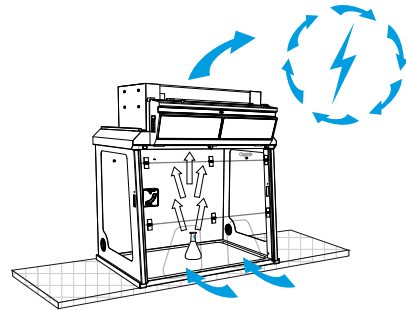

Easily relocatable and instantly ready to use

Captair® solutions may be moved from one location to another within the same laboratory according to your protection needs. They can be easily relocated without affecting the hood's air balance.

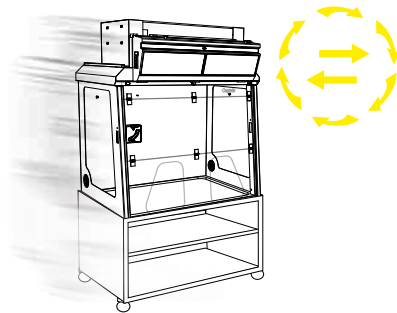

Eliminate installation costs

Implementing a Captair® solution is simple and quick. It does not involve the installation of a ventilation system for air supply and extraction as required by ducted systems. A single electrical outlet is all you need to run a Captair® Flex® fume hood. It can be installed at any time, without any complex preparation.

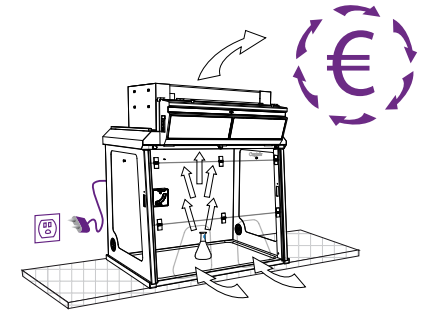

Protect the environment

Free of any ducted air flow system, Captair® solutions eliminate direct emissions of pollutants into the atmosphere and help protect the environment. They also avoid pollution generated by the energy needed to run the airflow systems of traditional ducted fume hoods.

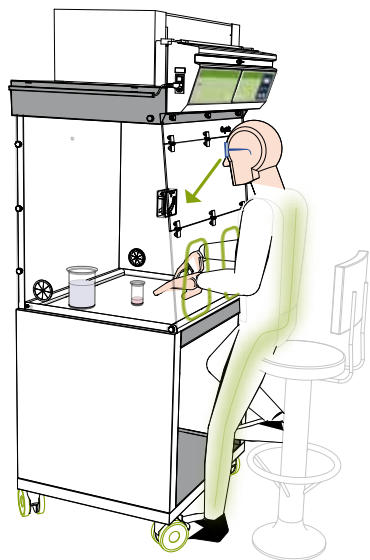
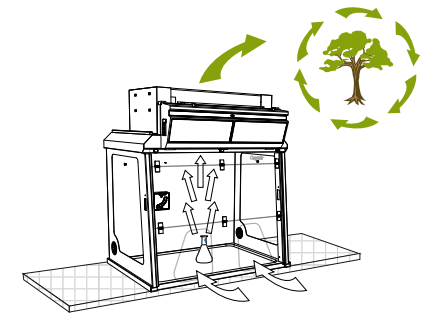

Quality design

With over 90,000 Captair® units in operation worldwide, our internationally-recognized experience allows our developers to design solutions that optimize your chemical handling while using our filtered workstations. This experience enables us to offer product lines that provide safety, functionality, and comfort in terms of use and maintenance.

Enclosure dimensions

- Enclosure width: from 80 cm to 180 cm
- Large instruments can easily be placed inside
- Easy to integrate with current laboratory fixtures

Visibility

- The optical-quality synthetic glass panel provides optimal visibility of all activities performed within the enclosure
- Built in bright lighting, contributes to a better working experience

Front openings shield

- Ample room for movement within the enclosure
- Ergonomically slanted front with a central protective shield to prevent any risk of chemical projections

Installation - Maintenance

- Ready to install, quick assembly
- Very few tools required
- Simple maintenance operations

Working posture

- Activities can be performed either seated or standing, without fatigue
- Rounded-edge work surfaces: provide an armrest for the forearms
- Slanted front acrylic shield for a comfortable working posture

Quiet operation

Safety, environmental protection, and energy savings within your laboratory

The filtration technology used in the design of Captair® ductless fume hoods makes it possible to protect laboratory personnel when in compliance with the AFNOR NF X 15-211: 2009 safety standard criteria. This also allows the decrease of the laboratory's environmental and energy footprint, while reducing installation and operating costs.

In fact, an independent study* has shown that traditional extraction fume hoods represent a significant part of a laboratory's energy consumption. Every extraction fume hood contributes to the large amount of energy used by laboratories and consume on average 3.5 times more energy than an average-sized house. All the advantages offered by Captair® ductless fume hoods contribute to reducing your environmental impact and your energy running costs.

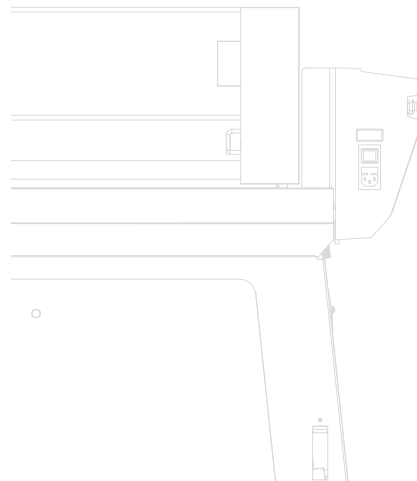

Calculate and compare the actual operating cost of a Captair® ductless fume hood Vs. a traditional ducted fume hood.

	For 1 Captair® fume hood
Structural work required	0 €
Makeup air & air conditioning	0 €
Annual energy cost*	between 5 and 30 €
Annual filter replacement cost	between 250 and 1000 €
Annual maintenance cost	between 150 and 220 €
Total average annual operating cost	between 405 and 1250 €

* Estimate based on: the cost of electricity for industrial use in France: 0.055 euros/kW - 8h/d for 218 days per year.

*Mills E., Sartor D. (2005). Energy use and savings potential for laboratory fume hoods. "Lawrence Berkeley National Laboratory". Elsevier; Energy 30 1859-1864.

The ESP[®] program —A set of three high quality services designed to ensure your safety included at the time of purchase—

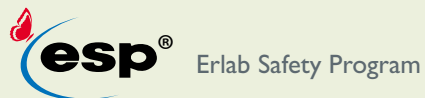

Erlab's commitment
to your safety

Our laboratory analyzes interactions between molecules and validates the right filtration technology for your applications.

Based on this scientific analysis, our laboratory will recommend the right filtration configuration, and the type of enclosure needed to ensure your safety.

After a captair enclosure has been installed, your ESP[®] specialist will provide at no extra cost long-term monitoring and reconfiguration services for your Captair[®] system based on the applications carried out within the hood.



The **ValiQuest[®]** service :
validates the ductless fume hood
best suited to your application

With the assistance of an ESP[®] agent, you will fill out an informational questionnaire in order to provide a detailed description of the chemical applications that you plan to carry out. Laboratory specialists will determine the right type of fume hood and filtration technology corresponding to your manipulations within 48 hours. We are committed to ensure your safety by certifying the feasibility of your applications.

The **ValiPass[®]** service :
certifies and confirms the appropriate use
of the fume hood at installation

When the fume hood is installed, a certificate of use will be provided, indicating which specific chemicals may be used, the type of filter, as well as the estimated filter life time. Your fume hood has been validated with these criteria in mind. This certificate serves to constantly remind the user and/or health and safety manager with regards to the proper scope of use of his/her hood.

The **ValiGuard[®]** service :
continuous monitoring of your ductless fume hood

Periodically (every 6 to 12 months), an ESP[®] agent will contact you to ensure that your applications have not changed and that the filter is still working effectively. The agent will guide you step by step through the filter saturation test and if needed will help you through the filter replacement procedure. If your applications have changed, the E.S.P[®] agent will ask you to fill out a new questionnaire (see step 1). After review, you will be sent a new Valipass certificate stating that these new chemicals can safely be handled under optimal safety conditions.

Contact your ESP[®] specialist at any time to configure YOUR Captair[®] safety solution with his or her assistance.

Online service: www.captair.com

Filtration technologies

Carbon filter anti-decompression system US patent number 7,563,301

The airborne pollutants in your laboratory

Chemicals, either in the form of gas and/or particles, present an inhalation risk that could affect the health of laboratory personnel. Health authorities have established concentration limits that may not be exceeded under any circumstances. These limits are defined by Occupational Exposure Limits (WEL/TLV), expressed in parts per million (PPM).

These dangerous, ever-present pollutants, generated by day-to-day handling of chemicals, require all laboratories to adopt preventative and protective measures in accordance with regulations in effect. Drawing on over 40 years of filtration technology experience, Erlab has developed Flex® technology,

which, through the combination of molecular and HEPA particle filtration technology, provides a comprehensive protection solution for most common applications found in various laboratory disciplines, environments and industries.

Molecular filtration technology: super-activated carbon

Activated carbon has been used for over a century because of its exceptional adsorption properties. Today, different varieties of activated carbon are used in various applications, such as water treatment, VOC treatment, solvent collection, chemical catalysis, etc.

Each of these applications requires a different type of activated carbon having specific, customized physico-chemical properties.

For over 40 years, our very active R&D division has been developing activated carbon-based filtration technologies that make it possible to adsorb airborne chemical pollutants in a stable, irreversible manner.

We offer a unique line of activated carbon solutions, sold as filtration cartridges, designed to protect laboratory personnel from inhalation risks.

A very strict set of specifications, developed by Erlab and based on compliance with international standards, allows us to select raw materials and to create technologies with the right porosity. Inspired by military-type gas masks, these technologies are able to adsorb a very wide range of molecules with no risk of desorption under normal operating conditions.

Our experience, based on over 30 years of testing, laid out in our Chemical Listing, is a testament to our in-depth filtration expertise.

The development of our filtration technologies also involves an environmental dimension. For instance, we decided many years ago to avoid using impregnation agents that are harmful to the environment.

Our filters are subject to strict testing, as set forth in the AFNOR NF X 15-211:2009 standard, the reference standard in the field of ductless fume hoods. The effectiveness of these solutions, as demonstrated by the results obtained, serves to guarantee users safety.

Regarding quality, each of our filters is delivered with a quality certificate that traces its entire production cycle.

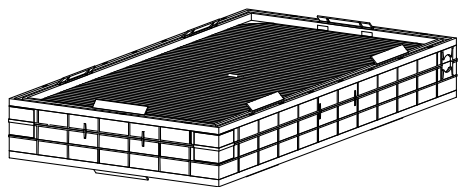

Types of carbon filters	
AS	For organic vapors
BE +	Polyvalent for acid + organic vapors
F	For formaldehyde vapors
K	For ammonia vapors

Particle filtration technology: HEPA H14

This filtration technology traps particles larger than 0.1 µm with 99.995% efficiency, according to the MPPS method set forth in the EN 1822-1 standard.

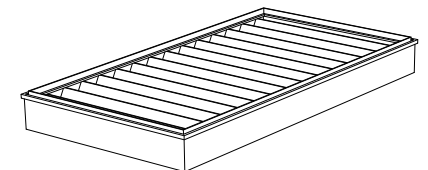

Flex[®] technology

US patent number 7,766,732 B



Modular filtration column

The fusion of molecular and particle filtration technologies makes it possible to configure a single device to meet all laboratory protection needs. This flexibility was made possible through the creation of stackable, one-size-fits-all, filtration cartridges—an innovation that is key to the new Captair[®] Flex[®] line. The modular filtration column adapts itself to the protection needs and specifications of the laboratory. The different models in the new line of Captair[®] Flex[®] ductless fume hoods can thus be equipped with 1 to 4 filtration columns, offering very high retention capacities. This innovation, developed by Erlab's R&D laboratory, offers unprecedented flexibility, adaptability, and savings. A single device can be quickly reconfigured and easily used for other applications.

The patented Revolving Filter system

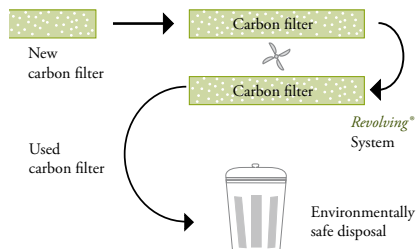

When the main filter is saturated, the molecules are automatically directed to a back-up filter. The back-up filter replaces the main filter when the main filter has reached its maximum saturation point. A new filter is then installed in place of the back-up filter.

The revolving system advantages:

- Significant optimization of the main filter life time;
- Substantial savings in terms of renewal costs.

Products handled	liquids	powders	liquids & powders	cleanroom
Applications	For diluting, proportioning, extracting, decanting, etc.	For sifting, grinding, weighing, formulating, compressing, etc.	For dissolving, filtering, extracting, etc.	For clean rooms rated up to ISO class 7.
Customized filtration column	<p>1C</p> <p>Class 2 according to the NF X 15-211:2009 standard</p>	<p>1P</p> <p>Class 2 according to the NF X 15-211:2009 standard</p>	<p>1P 1C</p> <p>Class 2 according to the NF X 15-211:2009 standard</p>	<p>1C 1P</p> <p>Class 2 according to the NF X 15-211:2009 standard</p>
Customized filtration column	<p>2C</p> <p>Class 1 according to the NF X 15-211:2009 standard</p> <p>Class 1 = Maximum protection</p>	<p>1P 2C</p> <p>Class 1 according to the NF X 15-211:2009 standard</p> <p>Class 1 = Maximum protection</p>	<p>2C 1P</p> <p>Class 1 according to the NF X 15-211:2009 standard</p> <p>Class 1 = Maximum protection</p>	

Class 1 ductless fume hood = Maximum protection guaranteed by the AFNOR NF X 15-211:2009 standard!

A filtration column configured in class 1 (1 main filtration level + 1 back-up filtration level) prevents chemicals from being released if the main filter reaches its saturation point.



captair[®] flex[®]

Ductless mobile fume hoods with modular filtration column

Designed to protect users during applications emitting vapors and/or chemical particles, the Captair[®] Flex[®] line offers a level of performance that ensures your safety while offering an environmentally-friendly alternative to traditional ducted systems.

Based on the Flex[®] technology -a flexible, adaptable modular filtration column- this line of chemical protection enclosures offers a wide range of possibilities and allows you to carry out a variety of applications in your laboratory.

The high containment and filtration performance of this technology offer users a high degree of protection, in accordance with the AFNOR NF X 15-211: 2009 standard, class 1 and class 2.

This technology is suited for many different industries, such as:
**chemistry, pharmaceuticals, cosmetics, biochemistry,
academics, petrochemistry, forensics, manufacturing,
agro-food, hospitals, etc.**

Modular filtration technology
customized for your applications

Air face velocity
monitoring system

Electrical and fluid lines
can be run into the enclosure

Vibration-absorbent
work surface, high chemical
and mechanical resistance



Automatic filter
saturation detection

Bright, energy-efficient lighting

Ergonomically designed
slanted front shield

Ergonomic openings

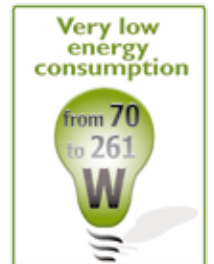

Flex® Technology



Commissioning, training, and maintenance offered by our Asura department and its network of licensed technicians.



M 321



Tested according to the ASHRAE 110: 1995 standard & compliant with the BS7989 standard Tests and markings 

Dimensions (mm) M 321 & Midcap

	L	D	H mini/max
Interior	764	543	866
Exterior	800	630	1160/1345

Technical specifications

	M 321
Number of filtration columns	1
Number of fans (IP44)	1
Processed air flow	230 m ³ /h
Air velocity at openings (in on-position)	0,4 to 0,6 m/s
Voltage/frequency	90 - 264 V / 50-60 Hz

	M 321
Including power used for lighting	70 W
Type of opening	Oblong
Structure	Anti-corrosion steel coated with 100% polyester
Panels	8 mm synthetic glass
Filtration module	Polypropylene

M 391



M 481



Flex[®] Technology

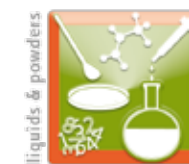

Except M 481



Tested according to the ASHRAE 110: 1995 standard & compliant with the BS7989 standard Tests and markings **CE**

Technical specifications

	M 391	M 481
Number of filtration columns	1	
Number of fans (IP44)	1	
Processed air flow	230 m ³ /h	
Air velocity at openings (in on-position)	0,4 to 0,6 m/s	
Voltage/frequency	90 - 264 V / 50-60 Hz	

M 391 M 481

Including power used for lighting (max)	70 W
Type of opening	Oblong
Structure	Anti-corrosion steel coated with 100% polyester
Panels	6 mm synthetic glass
Filtration module	Polypropylene

Dimensions (mm)

	M 391			M 481		
	L	D	H _{min x max}	L	D	H _{mini/max}
Interior	965	522	860	1240	522	860
Exterior	1000	630	1160/1345	1275	630	1160/1345

Flex[®] Technology



XLS 392



XLS 483



More info p.32



Tested according to the ASHRAE 110: 1995 standard & compliant with the BS7989 standard Tests and markings **CE**

Dimensions (mm)

	XLS 392			XLS 483		
	L	D	H mini/max	L	D	H mini/max
Interior	965	695	1040	1173	695	1040
Exterior	1000	800	1315/1495	1275	800	1315/1495

Technical specifications

	XLS 392	XLS 483
Number of filtration columns	2	3
Number of fans (IP44)	2	3
Processed air flow	460 m ³ /h	690 m ³ /h
Air velocity at openings (in on-position)	0,4 to 0,6 m/s	
Voltage/frequency	90 - 264V / 50-60 Hz	

XLS 392 XLS 483

Including power used for lighting	121 W	191 W
Type of opening	Total	
Structure	Anti-corrosion steel coated with 100% polyester	
Panels	6 mm synthetic glass	
Filtration module	Polypropylene	

XLS 633



XLS 714



Flex® Technology

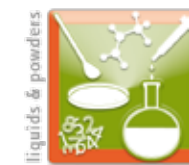

Except XLS 633



Tested according to the ASHRAE 110: 1995 standard & compliant with the BS7989 standard Tests and markings **CE**

Technical specifications

	XLS 633	XLS 714
Number of filtration columns	3	4
Number of fans (IP44)	3	4
Processed air flow	690 m ³ /h	920 m ³ /h
Air velocity at openings (in on-position)	0,4 to 0,6 m/s	
Voltage/frequency	90 - 264 V / 50-60 Hz	

Energy consumption

	XLS 633	XLS 714
Including power used for lighting	191 W	261 W
Type of opening	Trapezoid	Total
Structure	Anti-corrosion steel coated with 100% polyester	
Panels	6 mm synthetic glass	
Filtration module	Polypropylene	

Dimensions (mm)

	XLS 633			XLS 714		
	L	D	H mini/max	L	D	H mini/max
Interior	1566	695	1040	1765	695	1040
Exterior	1600	800	1315/1495	1800	800	1315/1495

Control panel

Flow monitor

This device allows for continuous monitoring of the ventilation flow rate and alerts the user via visible and audible alarm in the event of a ventilation system failure.

Adjustable timer

This timer records the number of hours that the device has been in operation and, every 60 hours, notifies the user the need to test the saturation level of the molecular filter. (In accordance with the requirements of the AFNOR NF X 15-211: 2009 standard).

Digital display for optimal data read-out

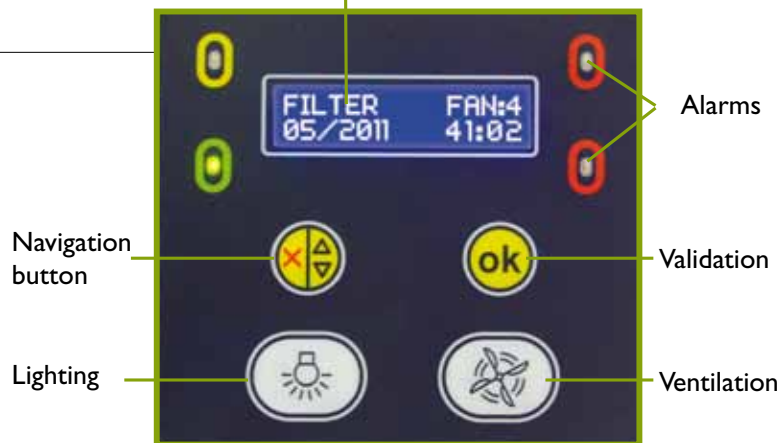

Sampling port



This port allows the user to sample the air within the detection chamber of the filtration module in order to evaluate the saturation level of the molecular filter, using color changing reagent tubes (not included).

(Equipment not included on devices set with the Molecode S automatic saturation detection sensor)

Anemometer



This system continuously monitors the face velocity, which must fall between 0.4 and 0.6 m/s. (in accordance with the requirements of the AFNOR NF X 15-211: 2009 standard).

Chemical Listing

A guide of Erlab-approved chemicals

This guide includes a comprehensive list of chemicals that Erlab certifies as tested and authorized for use within the hood, under the conditions set forth by the AFNOR NF X 15-211: 2009 standard.

The guide includes almost 700 chemicals and lists the following for each of these chemicals: name of the chemical, its formula, its CAS number, its boiling point, its molecular mass, its saturation vapor pressure, the filter designed to trap this chemical and the retention capacity of this filter, the type of filter saturation detection system, the maximum mass of the chemical that may be introduced within the enclosure, and the name of the testing laboratory that performed the test related to this chemical handling.

Energy-efficient lighting



Internal Lighting
18 W - 500 lux
- IP67.
Compact fluorescent tube lights. One

to three tubes, depending on the model. Dust and vapor-tight. Even, bright lighting of the work surface.

Side panel utility ports



Located on the enclosure sides, these ports allow electrical cables and/or fluid lines to enter the enclosure with ease.



The product of 40 years of R&D!

Work surfaces

Glass work surface

- Tempered glass work surface with framing
- Ergonomic arm rest to work comfortably.



Phenolic resin work surface

- Work surface with built-in spill tray, made of phenolic resin, with an ergonomic arm rest to work comfortably.
- High chemical and mechanical resistance.
- Ideal for precision weighing operations.



Work surface in stainless steel 304 L

- High chemical and mechanical resistance. Rounded corners to facilitate cleaning operations.
- Built in spill tray.

(Only available for the models : M 321, M 391, XLS 483, XLS 714)



Work benches and shelves

Mobicap™*

- Metal rolling cart, equipped with 4 wheels (2 locking wheels).
- Allows the device to be moved safely.



*Only available for the Captair® Flex® M 321 and Captair® Flex® M 391 models

Benchcap™

- Fixed metal work bench.
- Equipped with 4 height adjustment jacks.



Internal metal sliding shelf for Mobicap™ and Benchcap™.

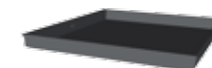

Molecode™ S



Large-spectrum filter saturation alarm.

(Equipment required by class I of the AFNOR NF X 15-211:2009 standard)

- 1 sensor is located in the detection chamber and automatically detects when the filter has become saturated by solvents.

- 1 sensor is in contact with the laboratory air and indicates an eventual pollution rise with solvents

Particle pre-filter

Eliminates particles > 0.3 µm to optimize the performance of the HEPA H14 filter.



Transparent back panel

- Made of synthetic glass.
- Offers 360° visibility of handlings performed into the enclosure
- Optimizes lighting conditions.



Rear access panel

- Made of steel.
- Located on the back side of the enclosure, this door provides easy access for large, heavy instruments.
- Ideal for maintenance operations. (Except on the Captair® Flex® M 321 model)

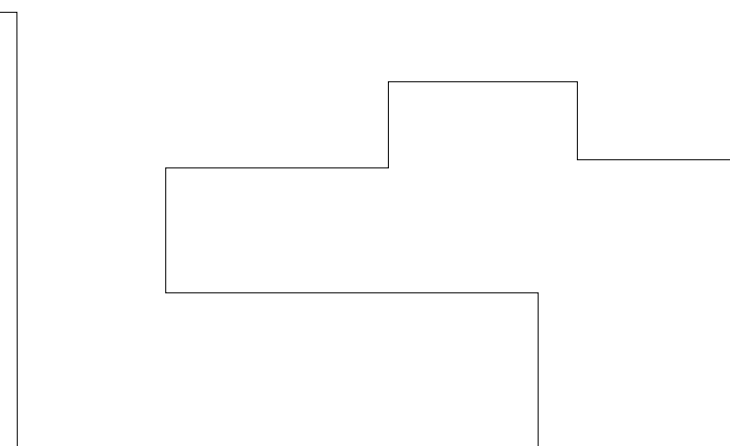



Secure weighing stations

Ergonomically designed to ensure safety during precision weighing tasks. Using a protective airflow, Captair® Flex® secure weighing stations provide a stable base for precision balances while offering a high level of containment and filtration performance that guarantee optimal protection for users (devices comply with the AFNOR NF X 15-211: 2009 standard, class 1 and 2).

Precise results

Captair® Flex® weighing stations are designed to allow weights to be measured with a precision up to 10^{-6} g.

 **captair flex**
Secure weighing stations



Modular filtration technology adapted to liquids and/or powders weighing

Automatic filter saturation detection

Bright, energy-efficient lighting

Ergonomically-customized for weighing activities

Vibration-absorbent work surface to ensure balance stability

Double-bag waste port with protective housing

Ergonomically designed slanted front shield

Workbench equipped with vibration-absorbent jacks

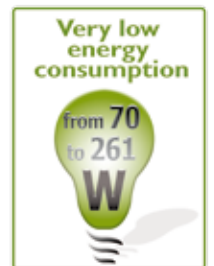

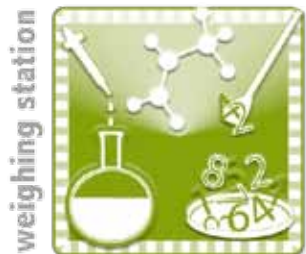

For the weighing of liquids and powders, either individually or combined



Commissioning, training, and maintenance offered by our Asura department and its network of licensed technicians.



Tested according to the ASHRAE 110: 1995 standard & compliant with the BS7989 standard Tests and markings **CE**

M 32I



M 39I



M 48I



XLS 392



Dimensions (mm)

	M 32I			M 39I			M 48I			XLS 392		
	L	D	H mini/max	L	D	H mini/max	L	D	H mini/max	L	D	H mini/max
Interior	764	543	866	965	522	860	1240	522	860	965	695	1040
Exterior	800	630	1160/1345	1000	630	1160/1345	1275	630	1160/1345	1000	800	1315/1495

* See pages 10-13 for additional technical specifications



Energy efficient Internal lighting

18 W - 500 lux - IP67.
Compact fluorescent tube lights. One to three tubes, depending on the model. Dust and vapor-tight. Even, bright lighting of the work surface.



Work surface made of solid phenolic resin

- Non-conductive material, very high mechanical and chemical resistance.
- Built-in spill tray.
- Guarantees precise, reproducible weight measures.
- Prevents static charges caused by items within the enclosure.
- Easy to clean.

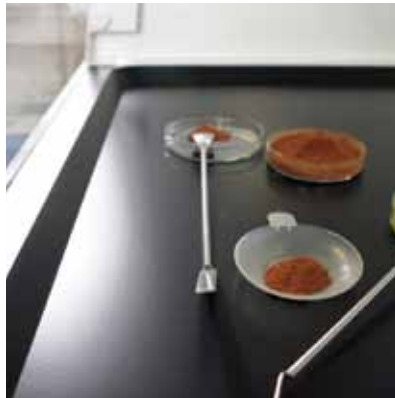

Waste port (optional equipment)

- Internal and external access secured by a protective air flow.
- Double-bag mounting system that prevents any waste from being released outside the enclosure.
- External housing to prevent bags from pulling free or tearing.



Benchcap™

Workbench that transforms the weighing unit into a true independent work station.

- Equipped with 4 vibration-absorbent jacks used to level the weighing station.





Vented filtering storage cabinets

Designed to store a wide variety of reagents used in the laboratory, Captair® Store™ vented filtering storage cabinets reduce the inhalation risks associated with the concentration of vapors into the lab environment.

Equipped with molecular filtration technology tested in accordance with the AFNOR NF X 15-211:2009 standard, these cabinets retain the toxic, odorous vapors emitted by chemical flasks and bottles.

Since they are ductless, Captair® Store™ cabinets do not release any pollutants into the atmosphere and may be installed near the work station. The recirculation of filtered air also allow Captair® Store™ cabinets to purify the laboratory ambient air.

Designed for all storage requirements, all areas, and all different reagent types, Captair® Store™ cabinets are the right solution for any laboratory where many flasks and bottles pollute the lab environment and take too much space.



NEW RANGE

Modular filtration technology suitable for any storage configuration

Very quiet ventilation system

Elimination of harmful, odorous vapors



No ducted airflow system needed

Purification of the ambient air into the laboratory

Double door to ease the opening in limited spaces

Sliding Polypropylene shelves with built-in spill tray (Approx. 4 Liters). Very high corrosion resistance

Double compartments For the storage of compatible and /or incompatible chemicals

High corrosion-resistance

Lockable storage solution



Very simple and quick commissioning
- Flat shipped to ease the laboratory access
- Mouting without tools

Storage capacity from 10 to 240 liters

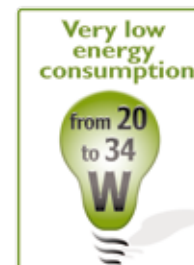

Commissioning, training, and maintenance offered by our Asura department and its network of licensed technicians.



Shelf 812

Storage capacity: 10 bottles (1 liter) containing compatible chemicals.



Ministore 822 small storage cabinet

Storage capacity: 48 bottles (1 liter) containing compatible and/or incompatible chemicals.



+ Tests and markings **CE**

Dimensions (mm)

	Shelf 812		
	L	D	H
Interior	783	202	348
Exterior	820	285	575
Option 812B		295	785



To be placed on a work surface or rear linear shelf
No.: 812 A



On legs, to be placed on a work surface
No.: 812 B



To be wall-mounted
No.: 812 C

Dimensions (mm)

	Ministore 822		
	L	D	H
Interior	753	322	475
Exterior	820	354	730
Option 822B		435	911
Option 822C		372	700



To be placed on a work surface
No.: 822 A



On legs, to be placed on a work surface
No.: 822 B



To be wall-mounted
No.: 822 C



To be placed under bench
No.: 822 D

Technical specifications

Filter type	AS (organic vapors) BE (organic chemicals and acids)
Fan	Quiet ventilation fan

Processed air flow	75 m3/h
Voltage/frequency	230 V / 50 Hz
Electrical power	20 W

Retention tray volume	812 : 2 liters - 822 : 2x2 liters (with absorbent mat)
Structure	Anti-corrosion steel coated with 100% polyester
Number of shelves	Ministore 822 : 8 shelves adjustable in height and 2 fixed.

832 NEW

Storage capacity: 120 bottles (1 liter) containing compatible and/or incompatible chemicals.

Cost saving solution !
Very low filter replacement cost



834 NEW

Storage capacity: 120 bottles (1 liter) containing compatible and/or incompatible chemicals.



1634 NEW

Storage capacity: 240 bottles (1 liter) containing compatible and/or incompatible chemicals.



The new Captair® Store™ range is :

- A polyvalent BE+ filter with a very high retention capacity
- +
- Polypropylene shelves with built in spill tray, very high corrosion resistance
- +
- A double compartment for the storage of compatible and / or incompatible chemicals



+ Tests and markings **CE**

Dimensions (mm)	L	D	H
832	800	510	2050
834	800	605	2175 mini 2255 maxi
1634	1600	605	2210 mini 2290 maxi

Technical specifications	832	834	1634
Filter type	AS BE F K	AS (organic vapors) BE+ (organic chemicals and acids) F (For formaldehyde vapors) K (For ammonia vapors) HP (HEPA H 14)	
Number of fans	1	1	1
Processed air flow	75 m³/h	> 75 m³/h	
Voltage / Frequency	230 V / 50 Hz	90 - 264 V / 50 Hz	

	832	834	1634
Electrical power	20 W	21 - 34 W	
Amperage absorbed	0,1 A	0,8 A	1,3 A
Metallic parts	Anti-corrosion steel coated with 100% polyester		
Door	Synthetic glass 6 mm		
Filtration module	X	Injected polypropylene	
Number of Shelves	10	10	20

Flex® filtration technology
For 834 and 1634 storage cabinets

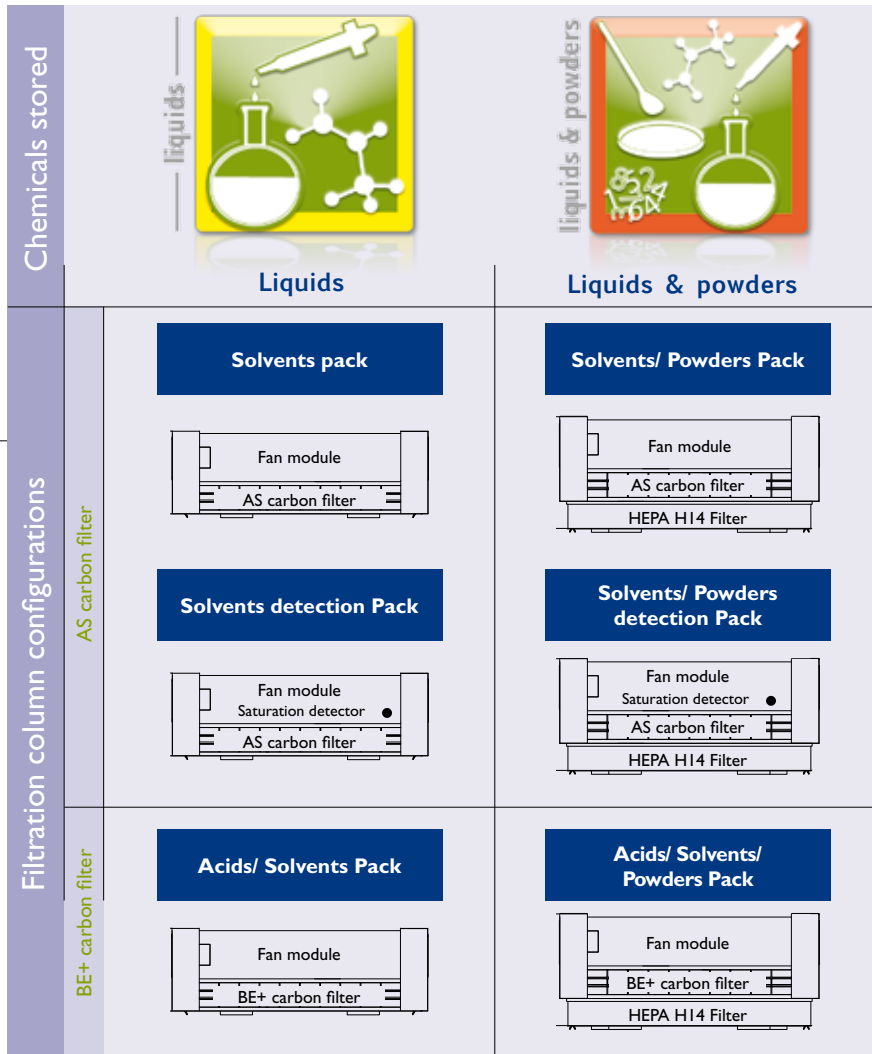

Standard equipment

	Flow monitor (Except 832)	Permanent ventilation control device in compliance with the EN 14175-2:2003 standard
	Sampling port (Except 832)	For filter saturation detection (N/A if Molecode S installed)
	Shelves	832 - 834 : 8 shelves adjustable in height and 2 fixed. Spill tray included. 1634 : 16 shelves adjustable in height and 4 fixed. Spill tray included.
	Lock	For a secured access to chemicals
	Chemical Listing	List of approved chemicals

Optional equipment

Molecode S* (Except 832)	Automatic alarm to detect filter saturation by solvents according to the NF X 15 211 : 2009 standard
Particular Pre-filter (Except 832)	Protect HEPA and molecular filters from dust contained into the laboratory environment
Double door	Ideal for limited spaces. For a small space. Radius door opening 34 cm
Additional shelves	Sliding Polypropilene shelves with built-in spill tray. Allows to improve the storage capacity for small containers

Types of filters

AS	For storage with a predominance of organic vapors
BE+	For storage with a predominance of organic vapors and acids
HP	HEPA H14 filter for powders storage
F	For formaldehyde vapors
K	For ammonia vapors

New Polyvalent filter

ChemTrap™ allows laboratories equipped with safety cabinets to also benefit from a protection against chemical inhalation risks.

ChemTrap™ advantages:

- End-users protection, chemical vapors eliminated by filtration.
- Adaptable to a wide range of under bench and vertical safety cabinets.
- Contributes to renew and purify the air into a laboratory.

2 specific columns:

H 402

For standard vertical safety cabinets

V 201

For under bench safety cabinets



Working principle:

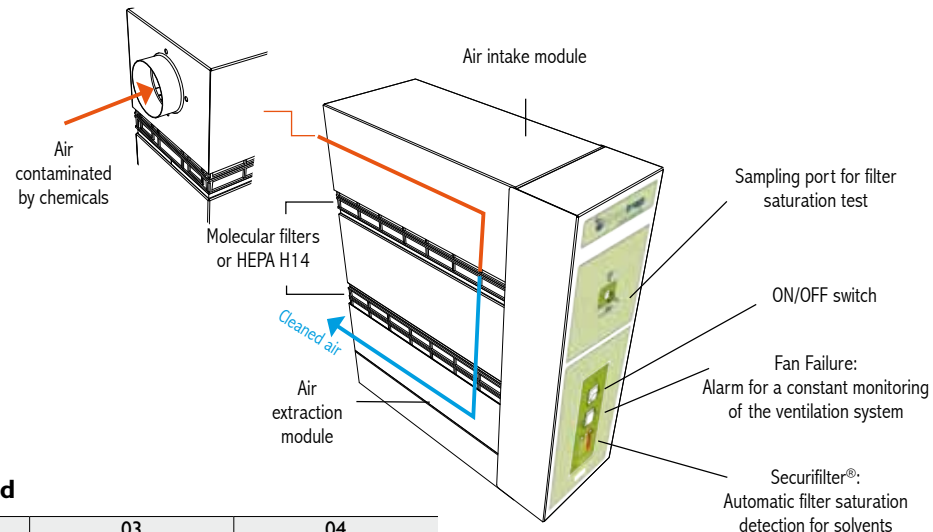

Advantages:

- Transform your safety cabinet into a standalone unit
- Fast and easy installation
- Eliminates ducting to an extraction system
- Compatible with a majority of safety cabinets
- Automatic detection of filter saturation

Commissioning, training, and maintenance

offered by our Asura department and its network of licensed technicians.



Dimensions (mm)	W	D	H
H 402	390	570	267
V 201	200	537	587

*Safety cabinet not supplied

Versions of Chemtrap™ offered

01	02	03	04
Sampling port	Sampling port + Fan failure	Sampling port + Fan failure + Sécurifilter	Sampling port + Sécurifilter

Technical data

	H 402	V 201
Types of filters	AS (For storage with organic vapors mainly) BE (For storage with organic vapors and acids mainly) HP (HEPA H14 for powders storing)	
Number of fans		1
Processed air flow	75 m³/h	> 50 m³/h
Voltage	230 V / 50 Hz	

	H 402	V 201
Electric power		19 W
Absorbed intensity		0,1 A
Flexible duct connection		1 meter (Ø 80 mm)
Flexible connecting flange		Ø 75 to 110 mm
Metallic parts	Anti-corrosion steel coated with 100% polyester	



HEPA filtered enclosure

Captair®Flow fume hoods make it possible to perform operations in an ultra-clean, dust-free environment.

The modular filtration column, which is equipped with a HEPA H14 filter, guarantees 99.995% filtration efficiency for particles larger than 0.1 µm (according to the MPPS method set forth in the EN 1822-1 standard).

The ultra-clean air entering the enclosure meets ISO class 5* (EN ISO 14-644 standard) requirements, which corresponds to American class 100 (i.e., less than 100 particles per cubic foot > 0.5 µm) and to class A and B of the GMP guide published by the European Union for the pharmaceutical industry.

Items located into the enclosure are therefore protected from any external contaminants.

Applications :

- Non-pathogenic cell cultures
- In-vitro cultures
- Microbiology (Non-pathogenic)
- Homeopathic preparations in pharmacies,
- Electronics
- Optics, etc.

Laboratories specializing in biology, botany, aerospace, electronics, pharmaceutical, cosmetics, etc.

NEW RANGE

4 new models :
With enclosures from 80 cm to 1,80 m

Optional carbon filter for the filtration of
ambient air gaseous pollutants

New stainless steel work surface
- Built in spill tray
- Spherical corners to ease the cleaning



HEPA H14 filtration
For handlings in ultra clean
environment, without dust

Very high brightness internal lighting
Very low energy consumption

Permanent ventilation
monitoring system

Ergonomical design
- Slanted front shield for a
comfortable working position
- Very large door opening to ease
the access into the enclosure

Air quality within the
enclosure ISO 5

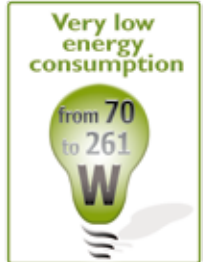

Effective protection for products and/or samples

321



391



483



714



**Commissioning,
training, and
maintenance**

offered by our Asura
department and its
network of licensed technicians.



Dimensions (mm)	321			391			483			714		
	L	D	H min/max	L	D	H min/max	L	D	H min/max	L	D	H min/max
Interior	764	549	866	965	522	860	1173	695	1040	1765	695	1040
Exterior	825	630	1160/1240	1000	630	1160/1240	1275	800	1315/1395	1800	800	1315/1395

Characteristics	321	391	483	714
Number of fans (IP44)	1	1	3	4
Filter type	HEPA H14			
Processed air flow	280 m ³ /h	305 m ³ /h	445 m ³ /h	590 m ³ /h
Voltage/frequency	90 - 264 V / 50-60 Hz			
Electrical power (max)	70 W	70 W	191 W	261 W
Amperage absorbed	0,26 A		0,72 A	0,98 A

*When used in a cleanroom in compliance with ISO 9 / EN 14-644 standard.

Flex® Technology

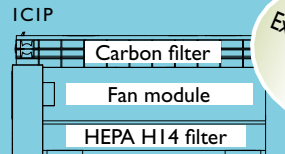
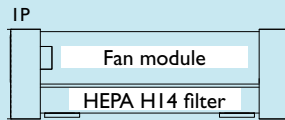

New!
Exclusive chemical protection feature

Adding a carbon filter to your vented cabinet allows you to protect its enclosure from gase pollutants present in your laboratory environment

Standard equipment

Control panel

Flow monitor: Continuous monitoring of the ventilation flow rate and alerts the user via visible and audible alarm in the event of a ventilation system failure.



Anemometer

Continuous monitoring of face velocity



Side panel utility ports

To run electrical and fluid lines into the enclosure



Energy-efficient Internal lighting

18 W - 500 lux - IP67.
Compact fluorescent tube lights. One to three tubes, depending on the model. Dust and vapor-tight. Even, bright lighting of the work surface.



Optional equipment

Work surface in stainless steel 304 L

High chemical and mechanical resistance. Rounded corners to facilitate cleaning operations. Built in spill tray



Phenolic resin work surface

Work surface with built-in spill tray, made of phenolic resin. Easy to clean.



Rolling cart MOBICAP®

(Exclusively for 321 and 391 models)

Metal rolling cart, equipped with 4 wheels (2 locking wheels).

Work bench BENCHCAP®

Fixed metal work bench. Equipped with 4 vibration-absorbent jacks used to level the unit

Shelves

Internal metal sliding shelf for Benchcap et Mobicap

Complete protection for gene amplification - Save time while saving your samples

Biocap™ DNA static enclosure

For applications with a small risk of sample contamination



Biocap™ RNA-DNA dynamic enclosure

For applications with a high risk of sample contamination



ISO 5*
air quality
within the
enclosure



Commissioning, training, and maintenance offered by our Asura department and its network of licensed technicians.

Highlights :

- Eliminates cross contamination risks
- Powerful UV decontamination rays system
- Biocap RNA / DNA for applications in an ultra clean environment, without dust

Dimensions (mm)	L	D	H
Interior	601	565	600
Exterior	653	610	730

Characteristics

Acrylic enclosure	10 mm
Internal volume of the enclosure	0,2 m ³
Total electrical power	26 W
Voltage/frequency	230V / 50Hz

Dimensions (mm)	L	D	H
Interior	601	565	600
Exterior	653	610	785

Characteristics

Acrylic enclosure	10 mm
Filter type	HEPA H14
Face velocity	0,53 m/s
Enclosure internal volume	0,2 m ³

The ultra-clean air entering the enclosure meets the requirements of ISO class 5 (standard EN ISO 14-644), which corresponds to American class 100 (i.e., less than 100 particles per cubic foot*)

Processed air flow	175 m ³ /h
Air renewal	90 time/min.
Voltage/frequency	230V / 50Hz
Electrical power	73 W

*When used in a cleanroom in compliance with ISO 9 / EN 14-644 standard.

Standard and optional equipment

Standard equipment

UV lamp

For decontamination within the enclosure.



UV cut-off

Automatic shut off of the UV lamp when the front shield is opened

Timer

To set UV lamp radiation time from 5 to 30 min.



Work surface

Made of steel with rounded edges.



Rear panel ports

To run electrical and fluid lines into the enclosure.



HEPA H14 filter (biocap RNA/DNA)

Traps particles larger than 0.1 µm with 99.995% efficiency, according to the MPPS method set forth in standard EN 1822-1.

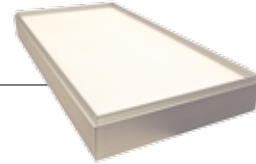

Optional equipment

Mobicap™ rolling cart

The Mobicap™ rolling cart is equipped with an adjustable inner shelf, giving the user the space needed to work while seated. The cart is equipped with 4 wheels (2 locking wheels).



Energy-efficient external lighting

500 lux, adjustable, allows the application to be properly illuminated. The lighting and ventilation systems shut off automatically when the UV lamp is turned on.



Mobile isolation enclosure

For research performed on-location and in the laboratory

- Protection of operators
- Protection of samples
- Ready to use
- Very little space required
- Easy to transport



Optimal air-tightness of the enclosure (Factory tested: compressed air inflation at 2.5 mm Hg, a certificate of compliance is provided with each enclosure)

Applications :

- Opening suspicious packages
- Working in an inert atmosphere (nitrogen, etc.)
- Collecting samples on-location (crime scene evidence, etc.)
- Revealing fingerprints
- Splash protection (biopsies, etc.)
- Performing activities that need to be sheltered from dust or humidity

Flexible PVC protective package for easy transport.



Dimensions (mm)	L	D	H
Exterior	860	560	725

Technical specifications

Enclosure and base	Flexible PVC, assembled using high-frequency welded seams
Closure	Double sealing groove
Medical gloves	Made of butyl rubber and PVC sleeves
Valve	Enclosure can be filled with an inert gas (nitrogen).

The AFNOR NF X 15-211: 2009 standard

All Captair® Flex® ductless fume hoods comply with this standard.

Commissioned by the AFNOR, the French Mechanical Standardization Union (UNM), made up of a committee of experts (the French National Scientific Research Institute (INRS), government agencies, professional associations), established the AFNOR NF X 15-211: 2009 standard. This standard applies to filtering fume hoods (also known as ductless fume hoods or ETRAF) designed for research work, analysis, teaching, etc. for all laboratories in which chemicals subject to occupational exposure limits (WEL or TLV-TWA) are handled. This standard sets forth performance and information criteria related to:

- **Filtration efficiency**
- **Containment efficiency**
- **Air face velocity**
- **The submission of a document listing the products that may be handled safely under the hood.**

Classes established by the standard:

Class 1	Class 2
Ductless fume hood with back-up filter	Ductless fume hood without back-up filter
A main level of filtration and a back-up level of filtration	A single level of filtration

Filtration-based classification:

	Designations according to the NF X 15 211: 2009 standard	Equivalent Erlab® product name
Particle filtration*	Type P	Type P
Vapor filtration**	Type V	Type C
Particle and vapor filtration**	Type PV	Type PC

*A particle filter must be at least type H14 according to standard EN 1822-1.

**Molecular filters must undergo two successive tests using cyclohexane and isopropyl alcohol for filters designed to capture Volatile Organic Compounds (VOC). Another test designed for acid vapor is performed with hydrochloric acid.

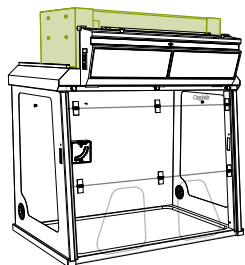

Filtration efficiency

This refers to the filter's ability to trap noxious molecules handled in the enclosure and characterizes the quality of the recirculated air downstream of the filters.

	Class 1	Class 2
Normal operating phase	Detection phase during which the concentration downstream of the filters must be less than 1% of the VLEP	
Detection phase	Detection phase during which the concentration downstream of the filters must be less than 1% of the VLEP and during which the automatic saturation detector should alert the user.	Detection phase during which the concentration downstream of the filters must be less than 50% of the VLEP
Safety phase	Safety phase during which the concentration downstream of the filters must be less than 50% of the VLEP and which must not last less than 1/12 the duration of the normal functioning phase.	Not applicable

The retention capacities recorded during tests performed on our filters demonstrate the technological performance developed by Erlab. These results guarantee users of our Captair® Flex® fume hoods a very high level of protection.

Sample test performed on a Captair® Flex® XLS 714 fume hood, equipped with class 1 BE+ filters.

Isopropyl alcohol	Cyclohexane	HCL (35%)
2250 gr	3204 gr	7862 gr

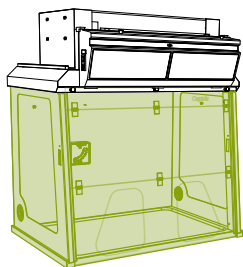

Enclosure containment efficiency

This refers to the fume hood's ability to keep vapors or particles inside the enclosure so that they are not released into the laboratory environment.

To confirm this efficiency, a test is carried out in accordance with the protocol set forth by the standard.

Tracer gas SF₆ (sulfur hexafluoride) is released within the enclosure. A grid made up of sensors is placed in front of the door openings. Air samples are taken at the grid location. Based on the concentrations of gas emitted and samples taken, which are used to define a user's average exposure to this tracer gas, it is possible to establish the efficiency of the ductless fume hood enclosure.

The containment limit set forth by the AFNOR NF X 15-211 : 2009 standard requires that the concentration of SF₆ gas must be ≤ 0.1 ppm at the grid detection points.

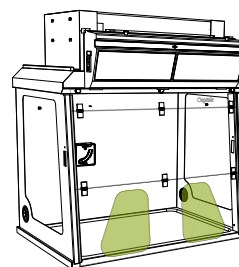

Air face velocity

This refers to the capacity of the fume hood to create a dynamic barrier between the user and the chemicals being handled.

For ductless fume hoods with a fixed front shield, air face velocity at all openings must be between 0.4 and 0.6 m/s. These fume hoods must also be equipped with a system to continuously monitor the ventilation system, which is itself an indicator of proper containment.



Documentation

Ductless fume hoods must be accompanied by a booklet that includes an exhaustive list of chemicals that the manufacturer has authorized for use within the fume hood in accordance with the conditions set forth by the AFNOR NF X 15-211 : 2009 standard. For each of these chemicals, the booklet must list:

- The name of the chemical, its formula, its CAS number, its boiling point, its molecular mass, and its vapor pressure.
- The part number of the appropriate filter and its retention capacity during the normal operation phase.
- The type of saturation detection system corresponding to the filter(s) in question.
- The maximum mass of the chemical that may be introduced in the ductless fume hood.
- The name of the testing laboratory that carried out the type test.

Erlab has created a guide that lists authorized chemical agents and provides an analysis of approximately 700 chemicals, the «CHEMICAL LISTING». This guide is delivered with each device as required by the standard.

International standards

Erlab® products comply with the following standards, thereby guaranteeing your complete safety:

France : AFNOR NF X 15-211 : 2009

U.K. : BS 7989

USA : ANSI/AIHA Z9.5

ASHRAE 110 : 1995

Asura®, Erlab's installation and servicing branch

Our team of specialists ensure installation, servicing and the follow up of your ductless fume hood, weighing station, vented storage cabinet, PCR work station, etc...

All safety enclosures vital features are therefore ready to use and tested by professionals thereby guarantying:

- Installation and user safety
- Good laboratory practices

Asura technicians also control:

- Air face velocity
- Containment
- Filters saturation level and verify all protection features provided by your safety enclosure in relation to the handlings / filtration type, filter replacement schedule, cleaning, ...

Asura® control process is based on AFNOR NF X 15 211, EN 14775, BS7989 standards compliance.



Asura® is also a partners network

Asura® also offers its services through a partners network that benefits from ERLAB's expertise.

Training

Erlab's 43 years experience, has allowed our Asura® division to offer personalised training sessions to maintenance providers and companies integrating a maintenance department.

Asura® service is not available in all countries, please contact us for more information.



asura[®], replacement filters

The filtration technology developed by the Erlab R&D laboratory allows us to offer a wide range of activated carbon filters under the brand Asura[®] filters

As a manufacturer making filtering enclosures compliant with AFNOR NFX 15 211 and BS 7989 standards, we apply the same level of quality to our Asura[®] filters design.

Offered at very competitive prices, their performances are suitable with a wide range of ductless fume cabinet brands: Astec, Bigneat, Cruma, Faster, Labcaire, Strola, Airclean, Air Science, Labcaire ... and much more.



NEW SERVICE

Buy your replacement filters on line!

For all brands of ductless fume hoods and vented storage cabinets

asurafilters.com
Reduce your filter budget!



With over 1500 references of replacement filters for ductless fume hoods and chemical storage cabinets, our new website Asurafilters.com provides a simple, fast, competitive and secured solution to purchase your replacement filters online.

Asurafilters.com offers replacement filters compatible with a wide variety of ductless fume hood and chemical storage cabinet brands such as Captair, Bigneat, Faster, Gelair, Astec ...

Visit us on the web

www.erlab.com

Get to know Erlab group, world leader in laboratory filtration technologies since 1968.



www.greenfumehood.com

Real time communicating fume hoods equipped with the new Neutrodine[®] filtration technology. For multi-disciplinary handlings



www.captair.com

Ductless mobile fume hoods and vented chemical storage cabinets for the total filtration of toxic gases. For single, dedicated applications.



www.asurafilters.com

Buy your replacement filters on line! For all brands of ductless fume hoods and chemical storages cabinets



International sales
sales@erlab.net

EUROPE			North AMERICA	ASIA			
<p>France & DOM TOM, Monaco</p>  <p>Erlab D.F.S. S.A.S.</p> <p>Parc d'Affaires des Portes BP 403 27104 Val de Reuil Cedex France Tel.: +33 (0)2 32 09 55 80 Fax.: +33 (0)2 32 09 55 90</p> <p>Ventes@erlab.net</p>	<p>Spain, Andorra, Portugal</p>  <p>Erlab S.L.</p> <p>Pol. Ind. Sur-Passaje Newton 3A 08754 El Papiol-Barcelona Spain Tel.: +34 93 673 24 74 Fax.: +34 93 673 24 76</p> <p>Ventas@erlab.net sales@erlab.net</p>	<p>United Kingdom, Belgium, Netherland, Irlanda, Norway, Sweden, Finland, Denmark</p>  <p>Erlab D.F.S. S.A.S.</p> <p>Tel.: +44 (0)1722 341 940 Fax.: +44 (0)1722 341 950</p> <p>SalesUK@erlab.net sales@erlab.net</p>	<p>Germany, Switzerland, Austria, Luxembourg, Liechtenstein</p>  <p>Erlab D.F.S. S.A.S.</p> <p>from Deutschland: Tel.: 0800 330 47 31 Fax: 0800 330 47 32 from Schweiz or Österreich: Tel.: +33 (0)2 32 09 55 80 Fax.: +33 (0)2 32 09 55 90</p> <p>Verkauf@erlab.net sales@erlab.net</p>	<p>Italy, Poland, Romania, Hungary, Czech Republic, Slovakia</p>  <p>Erlab D.F.S. S.A.S.</p> <p>Tel.: +39 (0)2 89 00 771 Fax.: +39 (0)2 72 097 812</p> <p>Vendite@erlab.net sales@erlab.net</p>	<p>U.S.A., Canada</p>  <p>Erlab inc.</p> <p>388 Newburyport Turnpike Rowley, MA 01969 USA Tel : +1 (800) 964-4434 Fax : +1 (978) 948-3354</p> <p>captairsales@erlab.com</p>	<p>China</p>  <p>Kunshan Erlab D.F.S. co Ltd.</p> <p>100 Liu Shi Jing, road Kunshan Development Zone Jiangsu Province Penglang - P.R. China 215333 Tel.: +86 (0) 512 5781 4085 Fax.: +86 (0) 512 5781 4082</p> <p>Sales.china@erlab.com.cn</p>	<p>Malaysia</p>  <p>Erlab asia sdn bhd</p> <p>25 Jalan Firma - /1 Kawasan Perindustrian Tebrau - 81 100 Johor Bahru, Johor State Tel.: +60 (0)7 3 555 724 Fax.: +60 (0)7 3 552 810</p> <p>Erlab@tm.net.my</p>

Other countries?
Contact us: sales@erlab.net



CAPTAIN-EN - 06/12 - Drawings, photos, text, and technical specifications are non-contractual. Erlab reserves the right to modify this document without notice. Erlab®, Asura®, Captair®, ESP®, and Flex® are registered trademarks of Erlab DFS SAS.



www.captair.com